

## Chapter 6

# Kites: Pioneers of Atmospheric Research

Werner Schmidt, William Anderson

**Abstract** Kites were essential platforms for professional exploration of the atmosphere for more than two centuries, from 1749 until 1954. This chapter details the chronology of kite-based atmospheric research and presents a brief examination of the well-documented scientific kiting based at the Royal Prussian Aeronautical Observatory. Parallels are drawn between scientific kiting from then and contemporary power-generation kiting. Basic kite types of the time are presented and the design evolution from those towards advanced payload carriers is discussed. These include the Lindenberg S- and R-Kites, the latter of which featuring an effective passive de-power mechanism. The practices of launch and retrieval of kites and the components developed for this purpose are outlined, in particular those in use at the Meteorological Observatory Lindenberg. Their methods and techniques represented the state of the art after WWI and lay the groundwork for modern efforts at atmospheric energy extraction using kites.

### 6.1 Introduction

The workhorse for performing tasks at altitude from the mid-1800s up until the advent of the powered airplane in the early 1900s was often the humble kite. These tasks included aerial photography [3], manlifting for purposes of military surveillance [28], and although less widely declared, airframe development for later untethered, manned flight (most notably the Wright brothers' wing warping kite of 1899 [18]). Kites were also indispensable in the development of wireless radio and telegraphy, in which kites were used by radio-pioneer and physicist Marconi to lift the first antennae to suitable altitudes for reception of messages transmitted via ra-

---

Werner Schmidt  
Strengeweg 14, 26427 Holtgast/Utgast, Germany, e-mail: [geschichte-mit-drachen@t-online.de](mailto:geschichte-mit-drachen@t-online.de)

William Anderson (✉)  
Advance Paragliders, Uttigenstrasse 87, 3600 Thun, Switzerland, e-mail: [will@advance.ch](mailto:will@advance.ch)

dio [7]. This period, roughly 1850 to 1910, is often referred to as the “Golden Age of Kites”, due in large part to the advances which occurred in kite technology and the increasing roles they played in practical life [28]. The most widely-mentioned application of kite technology during this Golden Age is the domain of atmospheric research. Fig. 6.1 shows a representative example of this era which extended in parts into the 1950s.



**Fig. 6.1** A Lindenberg R-kite with  $32 \text{ m}^2$  wing surface area flying over the Lindenberg Observatory in the 1950s [22]. Designed by Rudolf Grund, this type of kite was widely used for atmospheric soundings thanks to its stable flight characteristics and its self-regulating incidence angle, which reduced wear on both the tether and the ground fixation.

The period of modern Aerology began towards the end of the 18th century. In order to collect data for reliable weather predictions, meteorologists had begun to intensively investigate the condition and the evolution of not only the lowest earthen layers of the atmosphere, but also of higher atmospheric layers, data which included wind speeds, pressures and temperatures [28], initially using kites (and later also balloons). Interactions between atmospheric layers in terms of winds and also temperature profiles as function of height above ground were better obtained using kites

and this data was instrumental in making better weather predictions [19]. Two students at the University of Glasgow, Thomas Melville and Alexander Wilson, carried out the first known scientific kite launches in 1749, in which they measured the temperature of the atmosphere using releasable thermometers hoisted aloft on kites[21], preceding the existence of the balloon by some 30 years. Three years later Benjamin Franklin used kites to prove that lightning was an electrical phenomenon.

Kites were initially eclipsed by balloons in terms of preference as scientific data platforms. However, as soon as they were replaced by balloons they once again became predominant in the world of atmospheric data collection because of their superior performance in winds. Free flying weather balloons might carry instruments to extreme altitudes outside of the zones of interest, tethered balloons were largely uncontrollable and winds tended to push them downstream rather than into the air [19], involving exaggerated amounts of tether [28]. Kites indeed gained altitude in higher winds, with shorter tethers, and except in cases of tether breakage, were always retrievable. Very often it was exactly those moderate or high wind conditions which precluded the use of aerostats which were of interest to the meteorologists [19]. Kites also provided better exposure for the instruments [21]. Kites were also more cost effective than aerostats to fly the same payload [19].

## 6.2 Meteorological Observatories

The US Weather Bureau, the French Trappes Observatory, the Prussian Meteorological Institute, the Russian Central Physics Observatory, as well as the Belgian Uccle Meteorological Observatory were all involved in the development of kites, and their application to modern meteorology.

A rapid expansion of scientific kiting activities began in 1894, starting at the Blue Hill Observatory near Boston, under the direction of Abbott Lawrence Rotch. Initially, thermometers were sent up in order to read temperatures at altitude [5]. It was there that the first altitude records of 2900 m (1896) [19] and 4600 m (1900) were set. The Blue Hill Observatory were among the first to record atmospheric temperature inversions, and the first to correlate such phenomena for weather predictions.

Germany began somewhat later using kites in atmospheric research. There, the first coordinated, intensive experiments were conducted by Wladimir Köppen with funding from the German coastguard in the summer of 1898 near Hamburg. A large investment was made in 1899 for founding the Aeronautical Department of the Prussian Meteorological Institute, under the direction of Richard Assmann in collaboration with Arthur Berson near Berlin-Tegel [20].

Due to various accidents involving detachments of kite trains, the Observatory was moved to Lindenberg (Beeskow) in 1905, at the same time being greatly expanded [20]. This institute was founded for the operation of balloons and kites and was without a doubt the best equipped atmospheric science institute in the world, which explains why it played a primary role in the development of experimental atmospheric research using kites and also using airplanes.

The early development of kite technology was fundamentally influenced by the inclusion of safety measures caused by the ever increasingly dense electric power grid. Kite and tether technologies developed at Lindenberg were applied at other atmospheric science institutes as well [20]. Lindenberg Observatory flight statistics are summarized in Fig. 6.2. The first launches in Lindenberg in 1905 were still be-

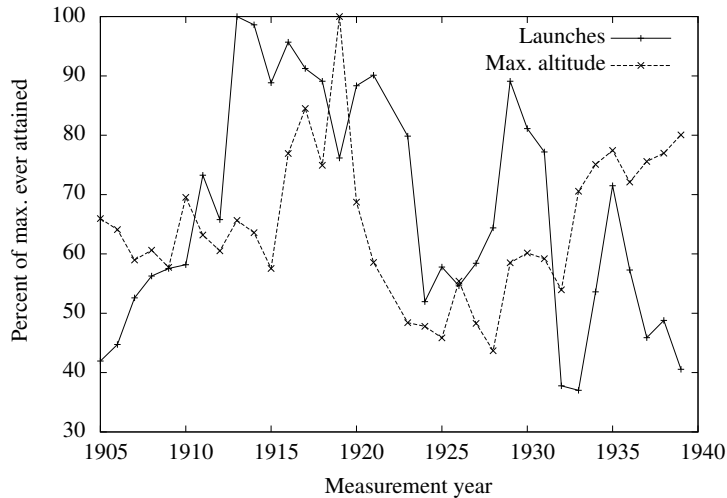

**Fig. 6.2** Yearly launches and maximum attained altitudes at the Royal Prussian Aeronautical Observatory in Lindenberg. Number of yearly launches ranged from minimum 292 to maximum 789. Maximum attained altitude in a year ranged from minimum 4260 up to maximum 9750 m [24]

ing conducted with a hand winch. The maximum attained altitude then was 6430 m. The technologies and methods of kite probes for atmospheric science were improved over the course of the years following, and as a result, altitudes of over 8000 m were possible from 1916 to 1919. On August 1, 1919, the current world record of 9750 m was set using a train of 7 kites.

The current altitude record for a single kite of 7550 m was set on July 23, 1935. On October 15, 1954, the R-kite was dispatched one last time from the winch house. The era of atmospheric measurements using kites and tethered balloons was coming to an end. From then on, meteorologists were able to take advantage of even more advanced atmospheric measurement technology.

### 6.3 Evolution of Kite Designs

Kites were the first man-made aerial vehicles, but they were initially only used as toys or perhaps for advertisement/signaling. The evolution from toy to scientific

payload carrier was influenced by the needs for low operational costs, robust and reliable operation, rapid setup in sometimes non-ideal conditions and easy maintainability. All of these criteria made balloons impractical. Complete theoretical treatments on kites were not available at that time. Simple construction methods were necessary because they were cheap and quick, resulting in low wing-loading and easy maintenance. The fabric covering of the lifting and control surfaces of kites was not rigidly formed like those of modern airplanes.

Kite structures encounter various strains and stresses. Wind pressure causes their fabric surfaces to balloon outwards, depending on their sizes. The frames, constructed from wood and thin wires, deform and bend. Atmospheric moisture and ice formation also modifies their behavior, as the supporting frame accumulates width (drag) and weight.

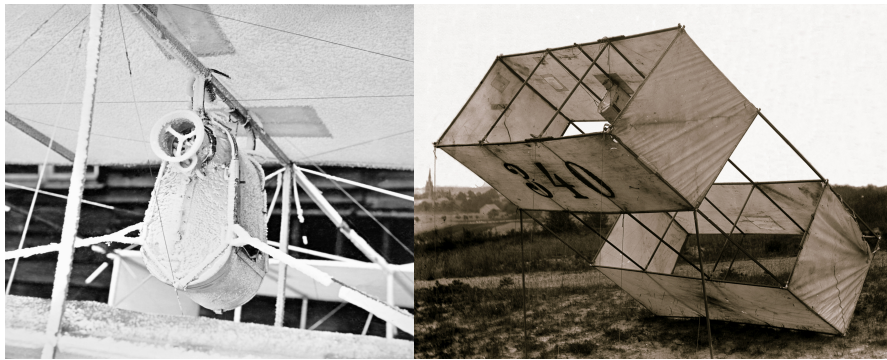
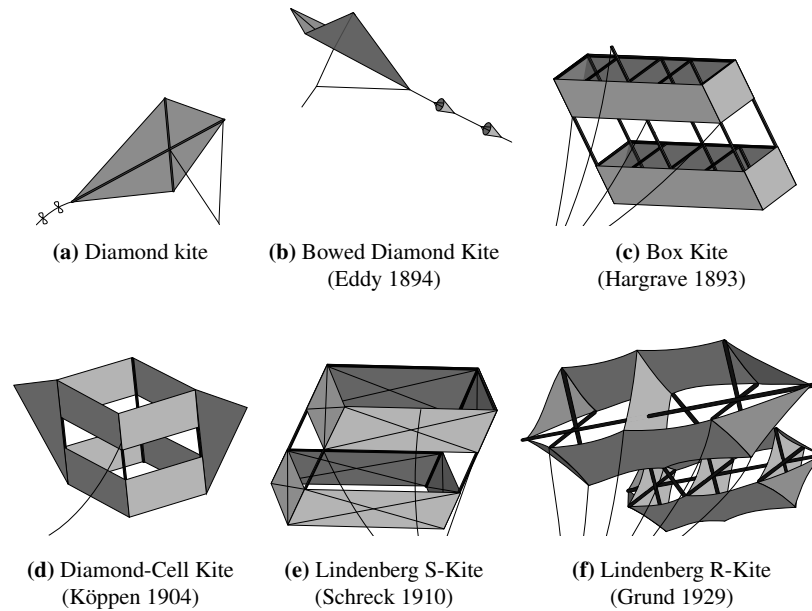

**Fig. 6.3** Lindenberg N-Kite (Normaldrachen) after exposure to extreme conditions: the installed measurement instrument, a barograph, along with the iced-over tension cables in the rear, which, according to [14] were 0.7 mm wide without ice (left), the kite after having been struck by lightning in 1906 (right)

The tether also introduces wildly varying forces, which required the enforcement of a variety of technical practices in the construction of weather kites. One method for reaching extreme altitudes was the kite train, in which a series of kites flew on the same tether. This practice prohibited the use of a kite tail for stability, which spurned on the development of tailless self-correcting kites. All of these considerations influenced the development of the scientific payload carrying kite.

### 6.3.1 Kite Types

The kite types that are presented in Fig. 6.4 and described below are not generic but are a mix of both fundamental and derived types. The evolution of the scientific kite design is represented by the alphabetic order of the pictures therein, starting with (a) the “toy” diamond kite which needed a tail for stable flight, moving on to Eddy’s



**Fig. 6.4** Important kite designs in use and developed during the “Golden Age” of kiting, after [24].

bowed diamond kite (b), which is a derivative of the Malay kite, whose dihedral added stability, such that a shorter tail or no tail at all was required. William Eddy perfected his invention at the Blue Hill Observatory [10].

Dihedral was an important landmark in the development of practical kites for science. A flat surface is ambivalently stable and is susceptible to large reactions to turbulence. Traditional flat kites achieved positive stability with the addition of a tail, but this tail was impractical for payload carrying kites, especially for kites flown in a train. Convex kites, either bowed or explicitly dihedralized, achieve positive lateral stability because a wind gust which perturbs the kite to one side results in a larger amount of lift on the side opposite of the wind gust, and thus, the kite self corrects. Especially meteorological payload-carrying kites must be largely immune to turbulence, and thus the addition of a convex dimension to the lateral axis of the kite such as that present in the Eddy kite was a large improvement for the scientific kiting world.

The remaining significant kite design revolution for flying payloads with kites encompasses the use of multiple lifting surfaces. Types (c), (d), (e) and (f) in Fig. 6.4 all derive from the fundamental box kite, and these designs have a larger total lifting surface and larger structural stability than the single surface varieties. Finally,

combining dihedral and multiple lifting surfaces such as types (d) and (f) results in a kite which is compact, lightweight, sturdy and stable.

### 6.3.2 Box Kite by Hargrave

The invention of the box or cellular kite is attributed to aviation pioneer Lawrence Hargrave. Having emigrated from England to Australia where he worked at the Sydney Observatory, Hargrave constructed in 1893 a double-celled tethered airframe which was capable to lift the inventor sixteen feet off the ground. Compared to the then customary flat kites, his box kite effectively doubled the number of lifting surfaces and the perpendicular side surfaces improved the flight stability. This kite is shown in Fig. 6.5. Perpendicular side surfaces improve flight stability for the same reasons that dihedral does. A wind gust which rotates the kite about its lateral axis results in a sideways inclination of the side surfaces, whose lift force tends to return the kite to the neutral position.



**Fig. 6.5** Lawrence Hargrave working on an experimental box kite, Woollahra Point, Australia, around 1910 [27]. The box structure affords very large stability for the given structural weight. It also provides plenty of fixation surface area for instrumentation.

For Hargrave, the box kite was the most suitable device for manned flight, and he built several versions in various sizes and configurations. He used simply profiled framing sticks or pre-bent spars underneath the upper lifting surfaces, which were the precursors for later airplane lifting surface profiles. Although Hargrave created in addition to kites also motors, with which he wanted to enable manned flight, he presented his kites in the US in 1893 with a different purpose in mind. He offered

his kites for meteorological measurement flights, which at that time were already being successfully performed using Eddy kites.

The meteorologists of the US weather bureau had experience with Eddy kites and had then begun testing the new box kites, as had the scientists at the Blue Hill Observatory. The Hargrave kite proved itself to be better than the Eddy kite. It flew with great stability and could be flown alone as well as in a train with several kites in order to reach extreme altitudes. Crash landings often resulted in little damage to the kite. For those reasons, Hargrave kites and their derivatives were the preferred choices for weather kites from 1895 onwards.

Hargrave's configurations provided for the first time an airframe which, built from materials commonly available, could withstand the loads required and was lightweight enough for lifting humans into the air. His designs influenced gliding pioneer Octave Chanute, who in turn influenced the Wright brothers, who achieved the first powered, manned flight in 1903.

It is also important to note the similarity between Hargrave's box kite and the subsequently designed Lindenberg N-kite (shown in Fig. 6.3, and detailed later in this work). The essential improvement in the Lindenberg N-kite are the four beams between the fore and aft wing units at their corners, which increase lateral rigidity of the airframe and therefore aiding the directional stability of the kite.

### ***6.3.3 Diamond-Cell Kite by Köppen***

U.S. Weather Bureau employee Samuel Potter improved the Hargrave rendering it sturdier and more stable in 1895 [17]. The resulting design was called the diamond kite because of its tether fixation on the corner of the frame rather than in front of one of the planar surfaces. This fixation technique resulted in less lines (less drag) than on the Hargrave, with larger flight stability due to the convex inclination of the lifting surfaces towards the free-stream.

Wladimir Köppen, the directing meteorologist of the German coastguard from 1875 till 1919, created a Kite Department in 1898 in Hamburg with the aim of improving weather predictions. He started out with replicas of the Hargrave kites for weather observations, then proceeded with his own creations; the "frog", the "step kite" and the "step box", ending up in 1904 with a rhombus-cross-sectioned box kite which he called the "brilliant kite". Upon learning that an English weather researcher had developed a similar kite, he named his kite the name given by Potter, the "diamond".

Köppen's diamond-cell kite is, like Potter's kite, an example of a dihedral kite, which means that not the full area of the cell but rather an inclination of the rhombus-shaped cells is orthogonal to in the wind. One improvement introduced by Köppen is the inclusion of movable sidewings, enabling "passive depower" as it is employed in modern power-generation kites. Both triangular areas of fabric are not rigidly attached to the cells. At high wind loads, they can fold back slightly, reducing the lifting surface. This reduces the danger of tether detachment. If the wind load dissi-



pates, a rubber spring returns the wing to its original position. This kite is shown in Fig. 6.6.

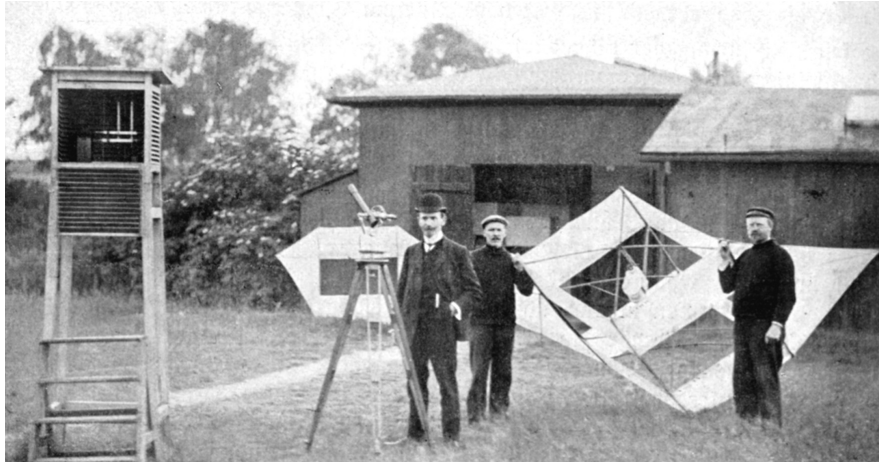

**Fig. 6.6** A Köppen diamond kite [24]. Köppen had the kite built in two sizes, with lengths of 1.28 and 2.14 m, each with and without outer wings.

### 6.3.4 Lindenberg S-Kite by Schreck

The Hargrave box kite was the inspiration for most payload carrying kite designs for the subsequent 50 years. The diamond kite was an immediate descendant of the Hargrave box kite. The N-kite was a more distant descendent of the Hargrave kite. In contrast to the Hargrave, its surfaces were not cambered, its cell corners reinforced with lengthwise spars [24].

Building on his experience as a kite carpenter, Hermann Schreck developed the umbrella kite as part of his function at the newly founded Lindenberg Observatory. Given its German name “Schirmdrachen”, in English umbrella kite, this new kite design is denoted as S-Kite. The kite that was used from 1910 onward at Lindenberg had various innovative elements which positioned the frame of the kite on the inside of the cell and to attach the frame to the covering at only very few locations. This kite is shown in Fig. 6.7.

To this end, Schreck introduced tension clamps as they are often used in umbrellas. Instead of the fixed spars along the inside of the fabric of the cells and along the leading edges, the cell structure was propped open like a tent, using the elasticity of the fabric in equilibrium with the tension provided by the clamps to provide a taut but flexible structure. The S-kite was produced in several sizes in order to serve in every wind situation. Kites with sailcloth of 5, 8, and 10 m<sup>2</sup> sizes were built,

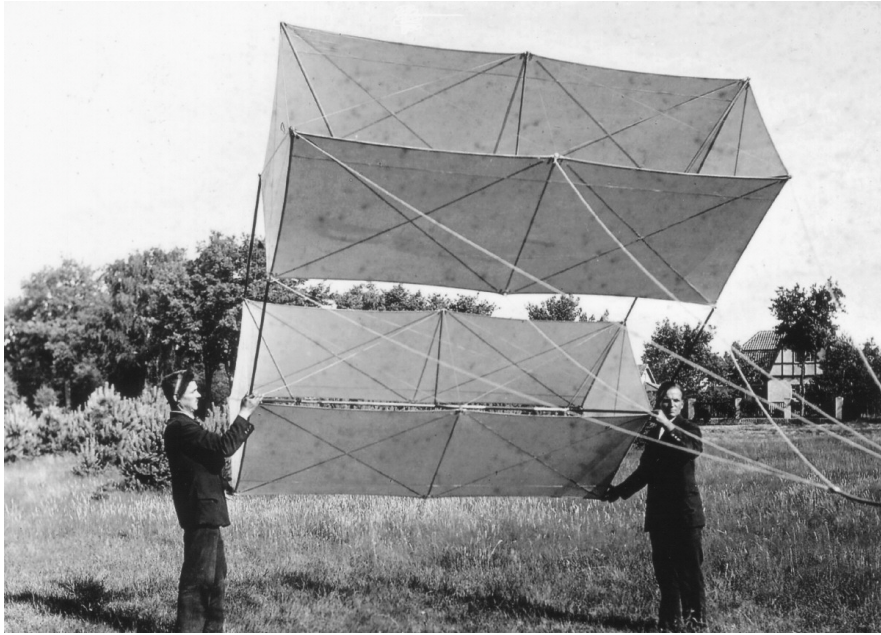

**Fig. 6.7** Lindenberg S-Kite (Schirmdrachen) using an umbrella-mechanism for pretension [24].

each with two equally sized cells. There was also a  $7 \text{ m}^2$  version whose rear cell was smaller than its front cell. The umbrella kites proved themselves as irreplaceable and reliable work-horses not only at the Lindenberg Observatory but also on numerous research expeditions [30].

The S-kite is even today the record holder for the highest kite altitude: on August 1, 1919, a train consisting of a main kite of  $10 \text{ m}^2$ , 6 helper kites of each  $8 \text{ m}^2$  and one remaining kite of  $5 \text{ m}^2$  reached a height of 9750 m.

### **6.3.5 Lindenberg R-Kite by Grund**

Rudolf Grund, director of launches at the Lindenberg Observatory, developed this self-regulating kite as the perfect lifter to top off a train of kites. Referred to in German as “Regulierdrachen”, after its inventor also as “Grund-Kite”, and denoted in this publication as the “Lindenberg R-kite”, this design incorporated several innovative features that increased the reliability of operation. Grund participated in research launches with balloons and kites since 1907. Already in 1916 he patented a depower mechanism for retrofitting to the then used box kites, allowing them to automatically adjust their angle of attack depending on the incident wind velocity and wing loading [13]. In the following years, he incorporated his ideas for improvement in a hinged dual-cell design [14]. The functionality of this kite is shown in Figs. 6.8

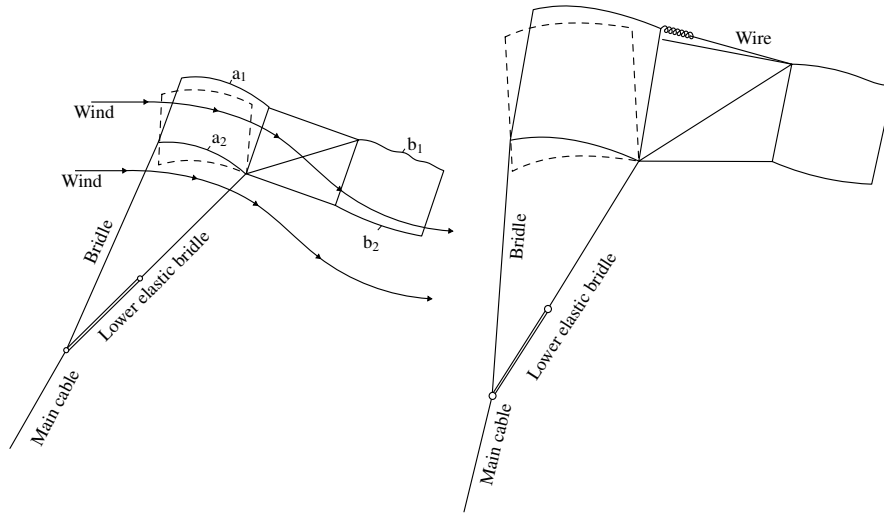

**Fig. 6.8** The passive depower function of a Lindenberg R-Kite [12].

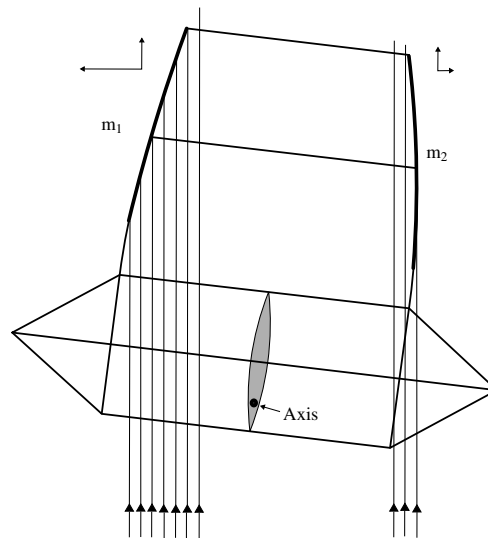

**Fig. 6.9** The action of the vertical stabilization surfaces of the Lindenberg R-Kite [11].

and 6.9. With his new kite introduced in 1929 he inherited from the umbrella kite the idea of an “inner skeleton”, however with two remarkable improvements:

1. The connection between the front and rear cells was not rigid but constructed such that the front cell lays flatter when the wind force increases, thereby reducing the tension on the tether. This flexibility between the front and rear cells increases the difference in the incidence angles between the main and secondary wings during moments of high loads, which moves the kite’s aerodynamic cen-

ter of pressure forward (and backwards when the incidence decreases). This is the concept of “self-regulation” (autonomous pitch correction) and it markedly reduced wear and breakage of the tethers [12].

2. The second improvement in kite technology seen on the Lindenberg R-kite was the enhanced yaw stability. The side-walls of the rear cell were banked at an angle of approximately  $7^\circ$  to the longitudinal axis. This, along with the fact that the vertical surfaces were positioned behind the tether fixation made the slope of the yawing moment curve more positive, known as “weathercock stability”. Asymmetrical directional disturbances returned the kite to forward orientation, because the vertical surfaces are located behind the tether and because of the pre-inclination [11].

Kites of 10, 16, 25, 32, 42, 64 and even  $100 \text{ m}^2$  lifting surfaces were built and flown. The various sizes meant that for every possible wind situation a fitting kite was available. The era of atmospheric data gathering by kite was coming to a close just as the R-Kites reached their apogee. Just as the R-kites often topped off the kite trains, they also topped off the kite era in meteorology.



**Fig. 6.10** A restored Lindenberg R-Kite with  $32 \text{ m}^2$  wing surface area [25]. The photo clearly displays the hinged dual-cell construction which allowed the kite to adjust to varying wind conditions.

## 6.4 Progress in Launching Technologies

Large scale kite launches required a large number of accessories including tethers, winches, ground stations, kite grips and further inventions for fixing the kite as

well as measurement instruments for recording data. The following sections briefly describe selected elements that are also of importance for the contemporary use of kites.

### **6.4.1 Tethers**

For effective kite launches above 500 m altitude “lines” made from crucible steel cable were used. Yarns or strings of equivalent strength were too heavy and had too large a diameter, and as a result were impossible to fly to high altitudes because they were too easily pushed downwards by the wind (and gravity). Cast steel wire was manufactured at a very high quality by Felten and Guillaume (in Cologne-Mühlheim) and by Moritz Poehlmann (Nuremberg). This wire was available on spools of 1-4 km length and in diameters of 0.7-1.1 mm. This cable was wound onto the spools of the winch and, using a special splicing technique, could reach a total length of up to 20 km!

The breaking strength of a 0.7 mm cable was 110 kg, comparable to a yarn of hemp of ca. 4 mm diameter. 1000 m of 0.7 mm wire weighed 3.1 kg. The same length of 4mm hemp yarn was 10-15 kg, therefore up to 5 times heavier. The brittleness and small diameter of the wire required careful handling. The wire needed to be protected from any damages which reduced the diameter. Especially corrosion was to be avoided. Therefore the wire needed to be continuously oiled during humid weather. This was easily achieved by oiling the main wire spool, and furthermore, the wire was led through oil-soaked felt buffers. This prevented water, which accumulated on the wire during launches into clouds, from arriving on the main spool during retrievals. Any activities leading to sharp bends or kinks of the wire were to be avoided at all costs. These kinks most often resulted from wire loops which did not straighten themselves out under tension. In general all loops needed to be avoided. It was therefore beneficial to cut out any strongly twisted lengths of wire. Wire twists most often occurred when the wire was led onto too narrow spools under high tension.

If the kite train pulled up and fell back at a high frequency then loops and twists would easily occur. The development of twists and loops could be largely avoided by using the largest possible spools. Wires needed to be replaced when used often, even if no damages were visible. This was especially true for the most heavily loaded parts, meaning the topmost wire segments on the spool, which were heavily loaded during landing maneuvers. At the Lindenberg Observatory, during periods in which the kite trains reached heights of 3-4 km on a daily basis, the uppermost 2-3 km were replaced every 4 months. The wire was replaced without exception in cases in which a large electrical load had occurred over the wire, even if no visible burns had occurred.

Because kites were then the sole atmospheric data acquisition platforms, the damage inflicted by their crashes and by the tethers on the ground were tolerated to an extent which nowadays would be unthinkable. One of these damage cases

was paraphrased as the “Lindenberg Wire-Cows”. When a tether landed in a pasture, if it was not retrieved, it was occasionally ingested by the mowing machines and distributed around the field in small bits, which, in cases of extreme bad luck, were ingested by livestock - mostly cows - who then died of metal intoxication. These cases were compensated by the Lindenberg Observatory. Since this was a well-known, if rare, occurrence, occasionally, certain less scrupulous farmers also tried to have the observatory compensate for cows which had died of natural causes [22].

### 6.4.2 Winches

Winches were indispensable auxiliary devices for launching, which were used to release and collect the tether. The most important component, the spool, an example of which is shown in Fig. 6.11, would be rotated with either human power or by a motor, which were then called “hand winches” and “motor winches”. Because hand winches needed a lot of time and work, they were rapidly phased out for regular launch operations.

Hand winches were only occasionally used for special investigations and to assist recoveries. Finally, they were also used on expeditions on which transportation difficulties prevented the freighting of fuel for a motor. In optimal wind and with an appropriately sized transmission which permitted 2-3 persons to overcome with kite force for a useful time-period, hand winches could be operated with useful yields. Recovery often took many hours. If the surface wind was weak or inexistent, the hand winch was not useful at all.

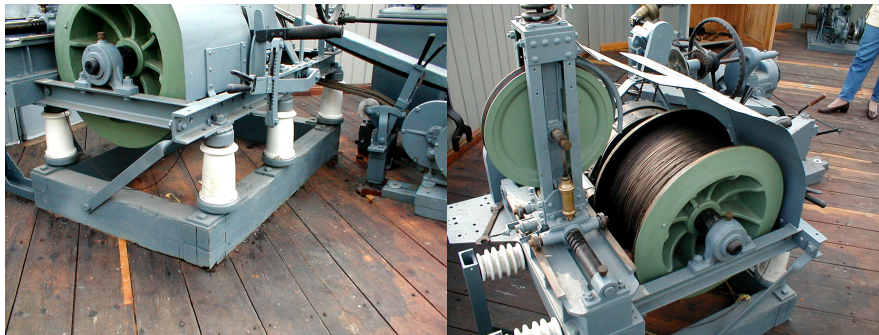

**Fig. 6.11** Components of the restored large kite winch at the Lindenberg Observatory [23]. The winches were insulated against static charges and lightning using large porcelain fixtures at the feet. Also visible are the handles and cranks with predefined slots for operating the azimuth swiveling functionality.



### 6.4.3 Stationary ground stations

At observatories at which there were several daily kite launches it was necessary to use stable, turnable winch houses. These made operation much easier. The rotational parts consisted of a platform which moved on rollers on an iron ring track [29]. The ground station at Lindenberg is shown in Figs. 6.1 and 6.12.



**Fig. 6.12** Azimuth pulley of the restored winch house at Lindenberg [23] (left) and historic aerial photo of the winch house showing the forest aisles required for launching [4] (right).

The entire contraption needed to be well protected against sand, ice, snow and corrosion. On top of this platform the house and its entire equipment was positioned. At the winch house in Lindenberg, the rotational crank for the house rotation was located in the middle of the house on top of a gear box. In other winch houses the rotation of the house was performed directly by hand. In order to have open visibility towards the sky it was beneficial to make the side walls of winch houses out of glass. The following equipment was recommended for large winch houses:

1. Balloon and kite winch including motor
2. Cable spool, replacement spool, replacement cable
3. a complete tool set
4. polishing wool, strings and clamp materials
5. workbench with vise
6. writing desk and filing cabinet
7. wire grips and wire rolls
8. measurement devices, binoculars, quadrant, clock
9. sufficient lighting devices for nighttime operation
10. Maps of the close and far vicinity for use in detachments
11. wind measurement device
12. fire extinguisher, first-aid kit, telephone (in later years), heating

When comparing the historic winch houses for atmospheric kites with contemporary ground stations of AWE systems the following can be recognized. Traction

power generation kites have a different mission cycle to those used for atmospheric research. Atmospheric research kites were flown for altitude and duration aloft. Traction power generation kites are also flown for altitude (power extraction is more efficient at higher altitudes) but traction power generation kites do not loiter at altitude, because the tether must remain in motion, either despooling or recovering. Also, the winch houses in the early 1900s were permanent structures. Kites of that time were not competing for airspace with aircraft, therefore, their operation could carry on without interruption all year. However, the need for azimuthal aim flexibility is present in both forms of operation. Whereas the ground stations in model AWE applications do not themselves rotate, the spool is able to be aimed in any direction. A good example of an AWE ground station is shown in Fig. 23.11.

#### **6.4.4 Mobile ground stations**

One practice already mentioned in this work was that of launching atmospheric research kites from ships at sea. This practice precluded the risks of ground impact damage by the tether or kite, and the mechanical turbulence over bodies of water is largely absent. Examples of marine deployment are shown in Figs. 6.13 and 6.14.



**Fig. 6.13** Launching of a Lindenberg N-kite on the Rovuma river in 1908 during the German aerological expedition for the exploration of the upper air in tropical East Africa [1, 6]



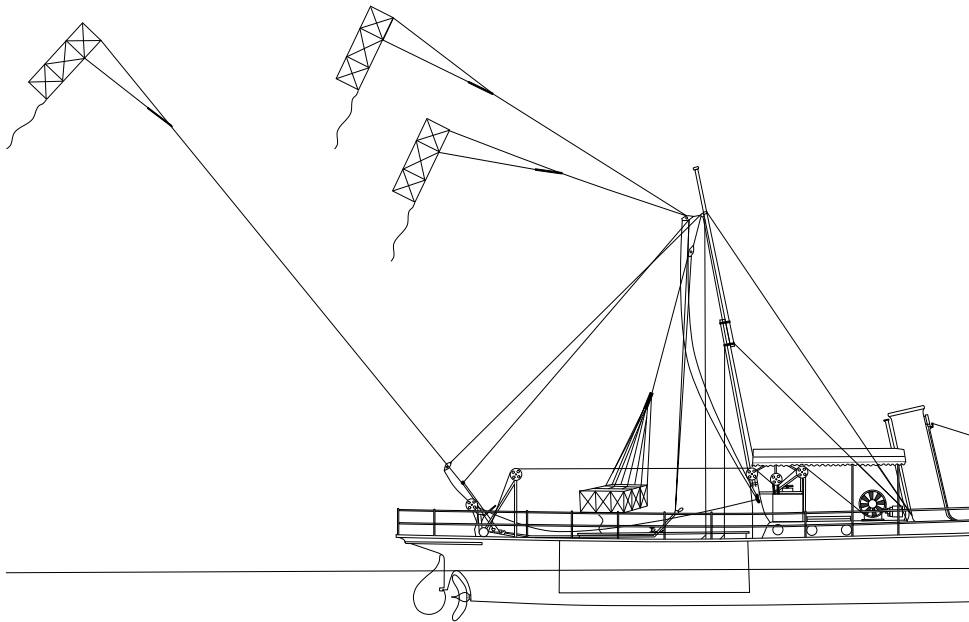

**Fig. 6.14** Kite launching sequence aboard the research ship “GNA” stationed on the lake Constance in Southern Germany (adapted from [26]).

## 6.5 Practical Launching Operation

This section outlines some practical aspects of launching and retrieving kites for atmospheric measurements. Much of the information is described in the historic literature, for example in [16].

### 6.5.1 General Tasks

The following list describes tasks that were required before, during and following a launch.

1. Prediction of weather and winds
2. Selection of the corresponding kite sizes
3. Check of the kites/balloons: strength of the tethers, strength of the coverings, correct positioning of the attachment. The kite was stood upright and the symmetry of the attachment was assured by pulling on the tether.

4. Check of the meteorological elements in the ventilated cabin, marking of the control positions on the meteorographs, estimation of the clouds, recording of this data into the launch protocol.
5. Attachment of the kite just before start
6. Check if the recording pins rest on the spool.

### ***6.5.2 Deployment***

The deployment of the already tethered kite was performed in order to avoid shaking the instruments. Straining the entire system was to be avoided at all costs. Deployment was performed in general with the wind, but in extreme cases when obstacles needed to be avoided, the kite could be deployed with up to 30 degrees angle to the wind on either side. The length of the deployment path depended on the wind distribution. If there was regular wind with a velocity of or above 6 - 8 m/s, then the kite could be deployed only 40 - 50 m away from the winch house. If there was weak or no wind then it was required to assess the existence and height of any available wind current at altitude either by using a pilot balloon or by observing the clouds. The kite needed to be deployed out at least 3 - 4 times of this height in order to reach that wind current at altitude launching from zero wind conditions. Based on these figures, the deployment radius could easily reach 4 - 5 km.

During an expedition in a Greenlandic Fjord, kites were transported out 4000 m using dog sleds on the sea ice in order to reach a wind current at 1000 m altitude. For longer stretches it was sometimes better to transport the kite and the tether separately.

### ***6.5.3 Release of the Kite***

Once deployment was complete, the kite was held by its side and stood up. A kite of 45 m<sup>2</sup> in gusty wind required very strong people. As soon as the launch director at the winch gave the signal (calling, waving, possible a pistol-shot, at nighttime a flash of light), the kite was lifted slightly up and the helpers ran along until the kite headed aloft. In case there were only two helpers available, the rear cell of the kite would be slightly buried or loaded with snow and then launched using the winch motor at top speed. Many such launches were executed on the Greenland expedition without incident.

#### ***6.5.4 The launch itself***

In the event of weak and gusty surface winds, launches were possible only with a large amount of patience and using individual gusts to launch, until enough cable was released. If the kite did not remain aloft after being thrown, then further attempts were often futile.

#### ***6.5.5 Recovery***

If the single kite or the kite train ceased to take out line then the recovery operation began. It was necessary to wait until the kite was as stable and stationary as possible. It was particularly necessary to observe if the equilibrium tension was too high, because then even a small recovery speed would damage the kite. The Lindenberg R-kites used in subsequent years could be retrieved as fast as was required and without interruption.

#### ***6.5.6 Landing***

As with all aerial vehicles, landing is the most difficult part of the kite's flight. Landing needed to be performed very differently according to the weather conditions. In weak or no wind conditions near the surface it was necessary to let the kite fall the last 400 - 500 m of cable length, and to let the kite glide in almost completely horizontally, because otherwise the danger was great that the kite would fly over the winch and crash top first into the ground, with large likelihood of damage. A general rule was that, the lower the tension is before landing, the lower the angle between the cable and the horizon should be. On the other hand when wind was very strong the R-kite could be wound in directly to the winch, just before which the helpers would grab it. After landing the disassembly of the kite would proceed, including inspection and immediate repair of any damages [15].

### **6.6 Review and Conclusions**

It is important to note that atmospheric research using kites did not completely disappear when the Lindenberg Observatory stopped using kites. Notable examples of modern kite-based atmospheric measurements are those performed by the CIRES group in Colorado [2], who sampled ozone levels along with traditionally sought data using what they refer to as a WindTRAM, a device which carries a payload up and down a kite tether.

Atmospheric research using kites resulted in important advances in kite technology, which continue to be implemented and refined in modern kite systems.

1. Passive depower concepts, which aerodynamically dissipate high loads before they are transmitted to the tether or to the ground fixation, introduced by Wladimir Köppen and Rudolf Grund, continue to be implemented today. The Skysails project, which reduces cargo ship fuel consumption through use of a propulsion kite, include passive depower concepts in their ram-air kites [9].
2. Adaptive azimuth swivel concepts continue to be implemented and evolved for ground stations of contemporary AWE systems [8].

There are however notable contrasts between kites used for atmospheric research and those used for airborne wind energy extraction:

1. Atmospheric research kites are payload carriers which need maximum passive flight stability. Airborne wind energy kites gain altitude flying a cyclical maneuver (often a figure-eight) under active control, and their passive flight stability is of secondary importance.
2. Atmospheric researchers using kites are not primarily interested in achieving high aerodynamic performance; they seek a perch for their instruments at extreme altitudes. Airborne wind energy systems directly depend on the aerodynamic performance of the kites. These must have a high lift-to-drag ratio in the power phase, in order to produce high power even in cross-wind conditions. In addition to that, the AWE kites must have a reasonable amount of aerodynamic performance in the depower phase, which implies the AWE kites not having only one optimum operating condition but a range over which performance is important.

Modern airspace did not exist as a concept during the “Golden Age of Kites”, there was no competition for flying objects at altitudes and legislation regulating the use of airspace did not exist. Higher population densities oblige modern kite systems to be carefully controlled. Ground damage from kite tethers such as the Lindenberg wire-cows would not be tolerated today.

The kites produced during these pioneering days, especially those used for Atmospheric Data Sampling in the 1890s and afterwards, were however of monumental importance in the overall development of kite technology. These kites inspired and informed the development of airframes which enabled the first manned flight. These technologies continue to be developed for ship propulsion and airborne wind energy.

**Acknowledgements** The authors would like to thank Walter Diem for providing additional photographic material and Roland Schmehl for feedback and critical review of the chapter contribution.

## References

1. Assmann, R.: The german aerological expedition for the exploration of the upper air in tropical East Africa, july to december 1908. *Quarterly Journal of the Royal Meteorological Society* **35**(149), 51–54 (1909). doi: [10.1002/qj.49703514908](https://doi.org/10.1002/qj.49703514908)
2. Balsley, B. B., Jensen, M. L., Frehlich, R. G.: The Use of State-of-the-Art Kites for Profiling the Lower Atmosphere. *Boundary-Layer Meteorology* **87**(1), 1–25 (1998). doi: [10.1023/A:1000812511429](https://doi.org/10.1023/A:1000812511429)
3. Batut, A.: La photographie aérienne par cerf-volant. Gauthier-Villars et fils, Paris (1890). <http://gallica.bnf.fr/ark:/12148/bpt6k1102849>
4. Berger, F. H., Behrens, K.: 100 Jahre Atmosphärensondierung - vom Drachen bis zum Windprofiler. Presented at the 7. Deutsche Klimatagung, Munich, Germany, 10 Oct 2006. <http://www.meteo.physik.uni-muenchen.de/dkt/presentationen/behrens.pdf>
5. Bridgman, R. L.: Weather Studies at Blue Hill. *The New England magazine* **18**(1), 40–55 (1895). <http://digital.library.cornell.edu/cgi/t/text/text-idx?c=newe;idno=newe0018-1>
6. Brönnimann, S., Stickler, A.: Aerological observations in the Tropics in the Early Twentieth Century. *Meteorologische Zeitschrift* **22** (2013)
7. Carnet de Vol. <http://www.carnetdevol.org/Wireless/marconi-transatlantique.html>. Accessed 25 June 2013
8. Delft University of Technology. <http://www.kitepower.eu/>. Accessed 14 July 2013
9. Euteneuer, B., Paulig, X., Drechsler, R., Brabeck, S.: Aerodynamic Wind Propulsion Device Having Bielastic Line Coupling. Patent WO 2010/020263, 25 Feb 2010
10. Fergusson, S. P.: Kite Experiments at the Blue Hill Meteorological Observatory. *Monthly Weather Review* **24**, 323–327 (1896). doi: [10.1175/1520-0493\(1896\)24\[323:KEATBH\]2.0.CO;2](https://doi.org/10.1175/1520-0493(1896)24[323:KEATBH]2.0.CO;2)
11. Grund, R.: Aus mehreren hintereinander angeordneten Flächen bestehende Seitensteuerung für Drachen. German Patent DE 506698, 6 Sept 1930
12. Grund, R.: Drachen mit selbsttätiger Einstellvorrichtung. German Patent DE 501362, 1 July 1930
13. Grund, R.: Drachen oder Drachenballon mit selbsttätiger Schrägstellvorrichtung. German Patent DE 302569, 11 June 1916
14. Grund, R.: Über eine neue Drachenkonstruktion. In: Assmann, R., Hergesell, H. (eds.) *Die Arbeiten des Preussischen Aeronautischen Observatoriums bei Lindenberg*, Vol. 16, pp. 1–6. F. Viehweg und Sohn, Braunschweig (1930)
15. Kleinschmidt, E. (ed.): *Handbuch der meteorologischen Instrumente und ihrer Auswertung*. Springer, Berlin (1935)
16. Köppen, W., Rotch, A. L.: Drachen. In: Suring, R. (ed.) *Moedebecks Taschenbuch zum praktischen Gebrauch für Flugtechniker und Luftschiffer*, Chap. 4. Krayn, Berlin (1911). <http://www.volny.cz/pompeius/moedebeck.html>
17. Marvin, C. F.: A Weather Bureau Kite. *Monthly Weather Review* **23**, 418–420 (1895). doi: [10.1175/1520-0493\(1895\)23\[418:AWBK\]2.0.CO;2](https://doi.org/10.1175/1520-0493(1895)23[418:AWBK]2.0.CO;2)
18. McFarland, M. W. (ed.): *The papers of Wilbur and Orville Wright*. McGraw-Hill, New York (1953). <http://hdl.handle.net/2027/mdp.39015003322461>
19. Millet, J. B.: Scientific Kite-Flying, with Special Reference to the Blue Hill Experiments. *The Century; a popular quarterly* **54**(1), 66–78 (1897). <http://digital.library.cornell.edu/cgi/t/text/text-idx?c=cent;idno=cent0054-1>
20. Neisser, J., Steinhagen, H.: History of the Meteorological Observatory Lindenberg 1905–2005. *promet* **31**(2–4), 82–114 (2005). [http://www.dmg-ev.de/gesellschaft/publikationen/pdf/promet/31\\_2-4.pdf](http://www.dmg-ev.de/gesellschaft/publikationen/pdf/promet/31_2-4.pdf)
21. Robinson, M. [http://www.kitehistory.com/Miscellaneous/meteorological\\_kites.htm](http://www.kitehistory.com/Miscellaneous/meteorological_kites.htm). Accessed 30 May 2013

22. Ruhe, B.: Werner Schmidt Leads the Way: Rediscovering the Kites of Lindenberg. *Drachen Foundation Kite Journal* 21, 3–8 (2006). <http://www.drachen.org/sites/default/files/pdf/Journal%20Issue%2021.pdf>
23. Schmidt, W.: Windenhaus Lindenberg. <http://www.wetterdrachen.de/heute/windenhaus-lindenberg/index.html> (2013). Accessed 27 July 2013
24. Schmidt, W., Diem, W.: *Drachen mit Geschichte*. Books on Demand GmbH, Norderstedt (2005)
25. Schmidt, W.: Fanø 2009. <http://www.wetterdrachen.de/heute/fanoe-2009/>. Accessed 27 July 2013
26. Snoek, H.: Die Drachenstation & das Drachenboot am Bodensee. *Sport und Design Drachen* 1, 52–57 (1998). <http://www.kapcasalboni.it/downloads/files/ID%20255.pdf>
27. State Library New South Wales. <http://acms.sl.nsw.gov.au/item/itemDetailPaged.aspx?itemID=456683>. Accessed 17 July 2013
28. Webster, G.: Kite for a Purpose (The Golden Age of Kites?). *The Kiteflier* 94 (2003). <http://www.thekitesociety.org.uk/PDF/Golden%20Years.PDF>
29. Whitehead, P., Whitehead, A.: September 1989, West Berlin. *The Drachen Foundation Discourse* 1(4), 37–42 (2009). <http://www.drachen.org/sites/default/files/pdf/Discourse%20Issue%204.pdf>
30. Winzer, C.: Entdeckungen in freier Atmosphäre: Die Geschichte der Wetterbeobachtung im Observatorium Lindenberg. *Monumente: Magazin für Denkmalkultur in Deutschland* 21(1), 56–60 (2011). [http://www.monumente-online.de/11/02/sonderthema/Meteorologisches-Observatorium\\_Lindenberg\\_.php](http://www.monumente-online.de/11/02/sonderthema/Meteorologisches-Observatorium_Lindenberg_.php)